



Sunda 2

Design by Allermuir

These beautiful occasional tables are available in various heights and diameters that can be nestled together to create a stunning multilevel center piece. The table tops are finished in a reformed Oak veneer that can be clear lacquered or stained,

whilst the Steel tripod frames are available in a fine textured, mineral colored range of powder finishes.

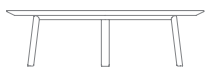

SUN201

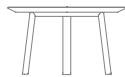

SUN202

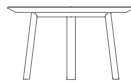

SUN203



SUN204



Design Allermuir

Our team of talented in house designers is responsible for creating elegant, innovative furniture designs that not only look beautiful, but minimise the impact on the world around us.

Constantly exploring new product trends and keeping up to date with the latest innovations in technology and materials, our design team creates world class designs of the highest quality.

Standard Features

(* - Selected models only)

Reformed Oak veneer face tops on 1" MDF with a cutback, clear finish edge profile

Tripod tubular steel frame

Plastic glides

Dimensions

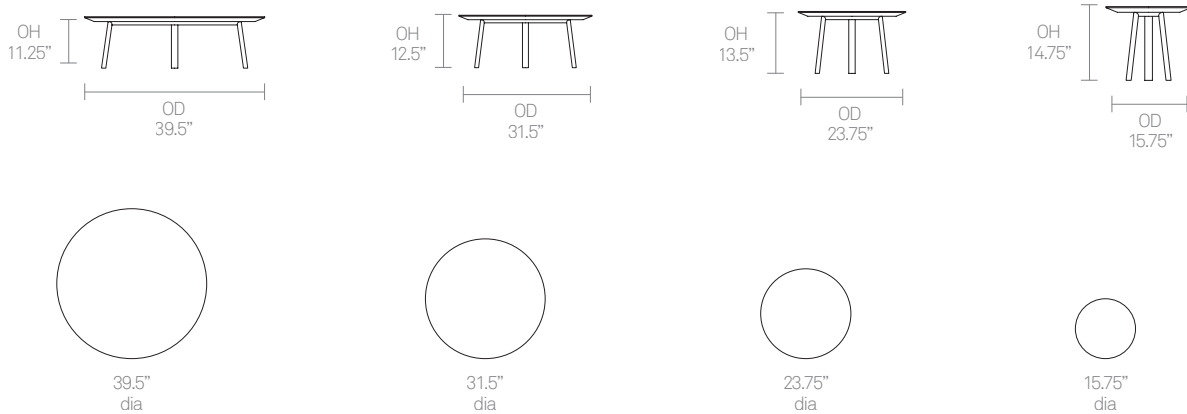

Environmental Performance

Material Content

Components are constructed of the following

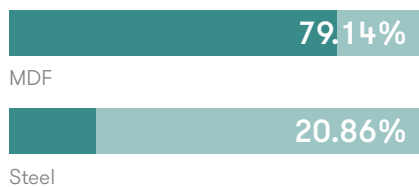

Recycled Content

Contains up to 46.05% of Recycled Material



Recyclability

The range is 99% recyclable

99%

Finish Options

Tripod leg frame available in Black, White, Slate Gray powder coat and all select mineral metal finishes

Oak veneer tops can be stained or color washed

Mainline Metal Finishes



Black

White

Slate Gray

Select Mineral Finishes



Mineral Night

Mineral Stone

Mineral Forest

Mineral Olive

Mineral Clay

Mineral Berry

Mineral Spice

Mineral Sand

Veneers & Laminates

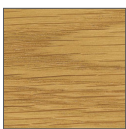

Oak Veneer

Color Washes based on Oak



White as Snow Wash

Back to Black Wash

Slate Gray Wash

Smoke Gray Wash

Vintage Red Wash

Ruby Red Wash

Fern Green Wash

Peacock Green Wash

Blue Skies

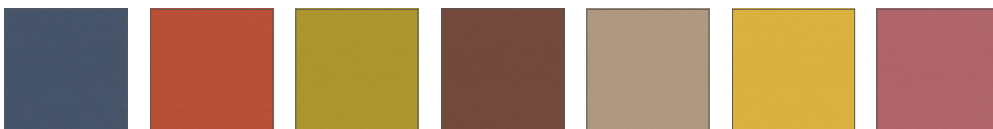

Sapphire Blue Wash

Orange Crush Wash

Mellow Yellow Wash

Nut Brown Wash

Turtle Dove Wash

Sherbert Yellow Wash

Blush Pink Wash

Note: Color images are for reference only. Please verify with actual color sample.

Wood Stains based on Oak



Clear



White Oak

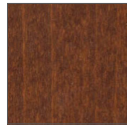

American
Cherry



American
Walnut



Dark Walnut



Wenge

Edge Stains



Solid Black



Solid White

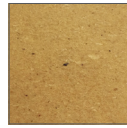

Clear

Edge References

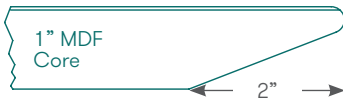

Ref Group Number 37

HPL laminate over a 1" MDF core counter balanced. The edge is cut back with a chamfer. The edge is clear finish as standard or can be stained.