



Stirling

Design by Allermuir

Stirling is an executive low level seating range for high quality reception and lounge areas. Designed with leather upholstery in mind, its style is emphasised by the robust yet elegant floating leg frame. Stirling provides an inviting sit with excellent

ergonomics and offers an arm chair, two seat or three seat sofa, ottomans of various sizes and a range of complementary tables.

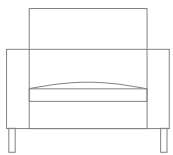

SL01

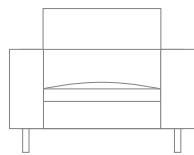

SLW01

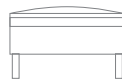

SLB01

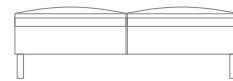

SLB02

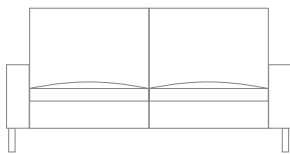

SL02

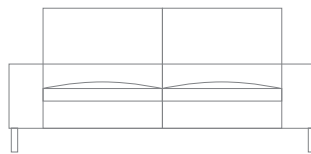

SLW02



Design Allermuir

Our team of talented in house designers is responsible for creating elegant, innovative furniture designs that not only look beautiful, but minimise the impact on the world around us.

Constantly exploring new product trends and keeping up to date with the latest innovations in technology and materials, our design team creates world class designs of the highest quality.



Stirling

Design by Allermuir

Stirling is an executive low level seating range for high quality reception and lounge areas. Designed with leather upholstery in mind, its style is emphasised by the robust yet elegant floating leg frame. Stirling provides an inviting sit with excellent

ergonomics and offers an arm chair, two seat or three seat sofa, ottomans of various sizes and a range of complementary tables.



SL03

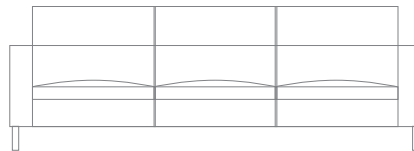

SLW03

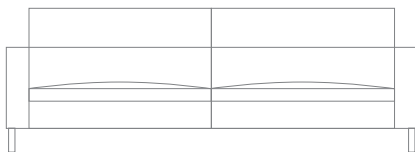

SL13

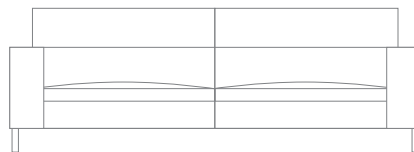

SLW13



Design Allermuir

Our team of talented in house designers is responsible for creating elegant, innovative furniture designs that not only look beautiful, but minimise the impact on the world around us.

Constantly exploring new product trends and keeping up to date with the latest innovations in technology and materials, our design team creates world class designs of the highest quality.

Standard Features

- (* - Selected models only)
- Coil sprung seat support
- Flat steel frame
- Zipped secure back cushion
- Plastic glides

Optional Features

- Fully upholstered
- Writing tablet for wide arm*

Dimensions

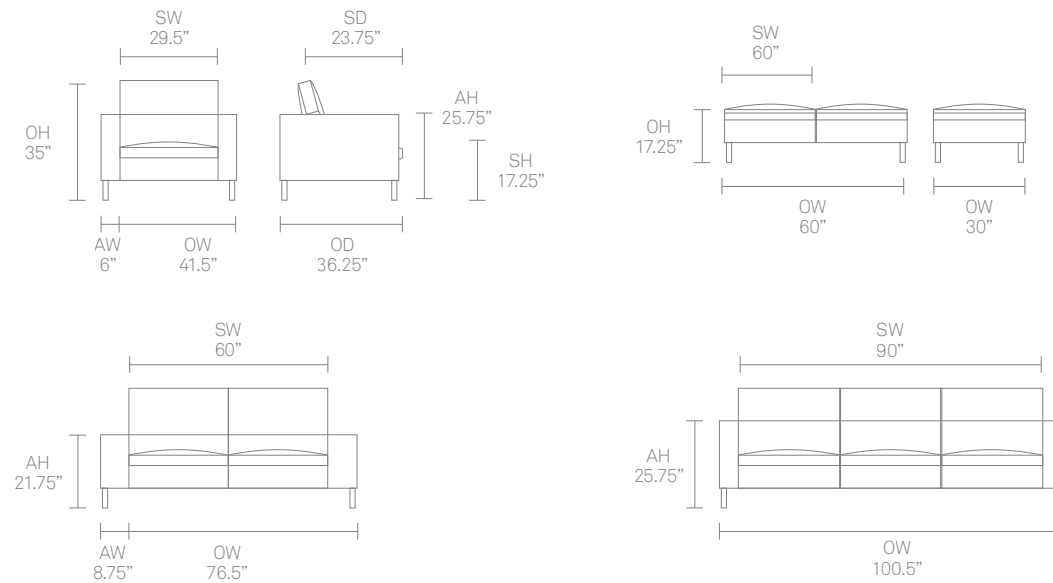

Environmental Performance

Material Content

Components are constructed of the following

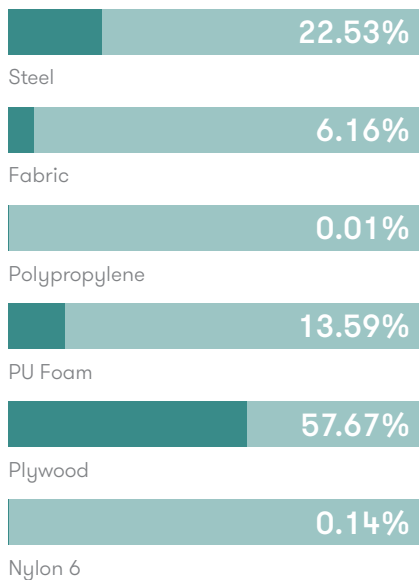

Recycled Content

Contains up to 14.50% of Recycled Material



Recyclability

The range is 99% recyclable

99%

Finish Options

Flat steel frame available in Brushed
Chrome

Stirling can be upholstered in a select
range of contract upholstery fabrics and
leathers from Allermuir standard collection.

Standard Metal Finishes



Brushed
Chrome